

KEYENCE

NEW Autofocus 1D and 2D Code Reader

SR-1000 Series



EtherNet/IP™



SETTING THE NEW STANDARD FOR CODE READING

SR-1000 Series

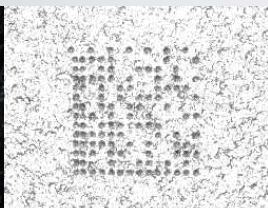

SR-1000 Series

3 CHALLENGES

CODE READERS FACE

1

READER CANNOT BE MOUNTED AT DESIRED DISTANCE

“Selecting the right reader and lens combination for the distance is frustrating.”
“The system has to be designed to fit the specifications of the reader.”



2

OPTIMAL SETTINGS ARE UNKNOWN

“Reading was successful during setup but there are many errors during actual operation.”
“Setup requires a whole day.”



3

READING FAILS DUE TO GLARE

“Do we need to mount the reader at a certain angle? What is the best angle?”
“Is external lighting required? What kind?”



1 ANSWER

JUST PRESS THE BUTTON



PRESS THE BUTTON

1

AUTOFOCUS

The reader can be mounted at any distance and maintain a clear image. (1000 mm max.)

2

AUTOMATIC TUNING

Determines optimal settings for exposure time, image processing filter, etc. [About 750000 combinations]

3

AUTOMATIC POLARIZATION

Glare can be eliminated. Reader angle adjustment or external lighting is unnecessary.

SETTING COMPLETE



Autofocus 1D and 2D code reader
SR-1000 Series



WORLD'S FIRST AUTOMATIC POLARIZATION CONTROL

The reader features both polarized and direct light sources. Automatic polarizing filter selection eliminates glare and allows flexible mounting.

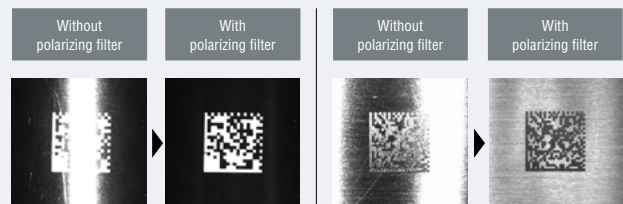

1

JUST PRESS THE BUTTON

AUTOFOCUS

ONE READER FOR MANY APPLICATIONS

Mounting is less restricted by performance or specifications of the code reader itself, thus improving flexibility in machine designs for production lines and jigs. With autofocus capabilities, a single reader can detect codes on targets of varying heights.

- Detecting targets with differing heights
- Securing a robot's movement range
- Reading extremely small codes

FIELD OF VIEW 4× LARGER

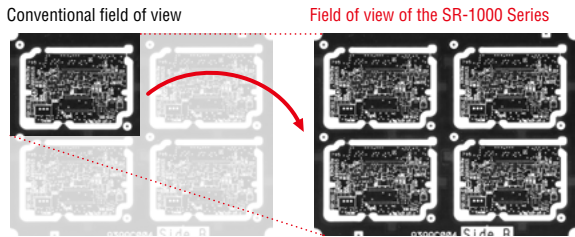

Range:
290 mm × 220 mm
11.42" × 8.66"

4× WIDER
than conventional models

EVEN IF THE POSITION
CHANGES



EVEN IF THE CODE IS
SMALL

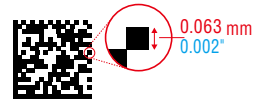

Distance:
110 mm
4.33"

Distance:
1000 mm
39.37"

1.6× LONGER
than conventional models

EVEN IF THE DISTANCE IS
FAR















AUTOMATIC TUNING

OPTIMAL SETTING OF EXPOSURE TIME, FILTERS AND MORE

The code reader automatically optimizes the exposure time, image processing filter and other parameters according to the target and mounting distance.

CLEAR IMAGE CAPTURE

CORRECTION ITEMS AND EXAMPLES OF AFFECTED CODES

 <p>Dark</p>	<p>CAPTURE BRIGHTNESS CORRECTION</p> <p>Automatically configures various combinations of exposure time, dynamic range and gain in order to achieve the optimal brightness.</p>	 <p>Black resin</p>	 <p>PCB</p>
 <p>Low contrast</p>	<p>CONTRAST THRESHOLD CORRECTION</p> <p>Automatically corrects black/white thresholds and optimizes the contrast between code and background.</p>	 <p>Metal</p>	 <p>Ceramic</p>
 <p>Thin printing</p>	<p>FILTER CORRECTION</p> <p>Automatically selects the best filter and filtering intensity to correct the captured image.</p>	 <p>Bleeding</p>	 <p>Thick printing</p>
 <p>Distortion</p>	<p>GEOMETRIC CORRECTION</p> <p>Corrects distorted codes, such as those on cylinders and other round surfaces or when the reader is mounted at an angle.</p>	 <p>Parallel distortion</p>	 <p>Trapezoidal distortion</p>
 <p>Stray dots</p>	<p>IMAGE REDUCTION & CORRECTION</p> <p>Reducing the image size may reduce background noise or missing spaces relatively smaller.</p>	 <p>Primary noise</p>	 <p>Dot printing</p>

LATEST TECHNOLOGIES PROVIDING STABLE READING

HIGH-SPEED SEARCH

2D CODE SEARCH IN CAPTURED IMAGES

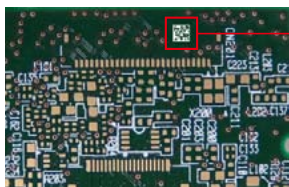

Binary processing enables immediate detection of 2D codes even if there is a code-like pattern in the field of view.

DEFECTIVE CODE POSITIONING PROGRAM

A newly developed defective code positioning program can identify four corners of a 2D code based on a similar code detection pattern, leading to a significant improvement in code detection performance.

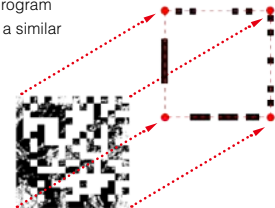

HIGH-LEVEL DECODING

CONTRAST ALGORITHM FOR LOCAL CONCENTRATION (CALC)

Our contrast algorithm for local concentrations divides a code into smaller pieces to perform binary processing using thresholds specified for each division. This enables accurate black/white classification without being affected by uneven print density.

CONVENTIONAL TECHNIQUE

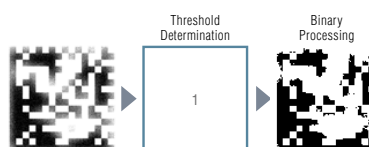

CALC TECHNIQUE

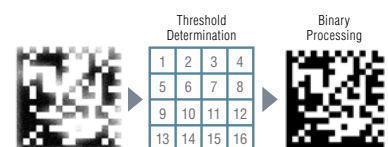

* The above illustration is only for reference and does not mean that a code is always divided into 16 parts.





AUTOMATIC POLARIZATION CONTROL

ENSURING FLEXIBLE MOUNTING

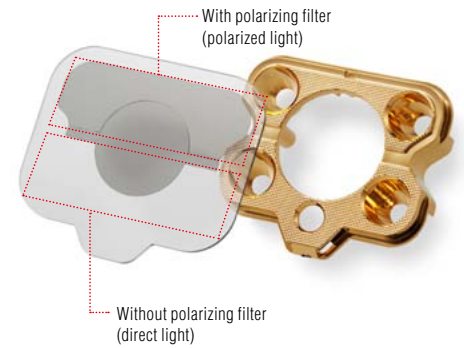
Automatic polarization control function World's First

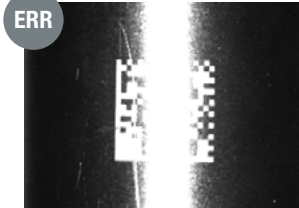
The code reader automatically eliminates glare, thus eliminating the need for mounting angle adjustment or external lighting during installation. When combined with the autofocus function, mounting becomes highly flexible.

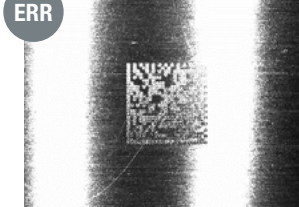
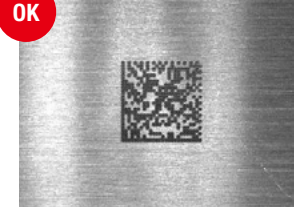

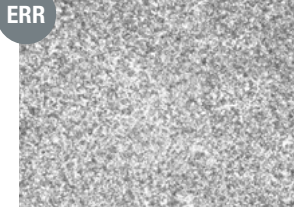
		Without polarizing filter	With polarizing filter
BLACK RESIN			
METAL			
METAL			

NEW OPTICAL DESIGN FOR STABLE READING

CPC (Compound Parabolic Concentrator) Illumination

A specially shaped reflector has been designed to create high efficiency illumination by reducing loss in light intensity from the high intensity LEDs. Gold plating maximizes the reflectance to achieve brightness exceeding conventional levels by 400%. This provides reading under bright, uniform illumination even at long ranges.



Conventional model

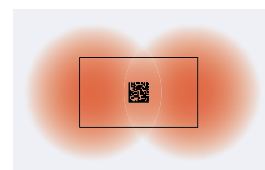

SR-1000

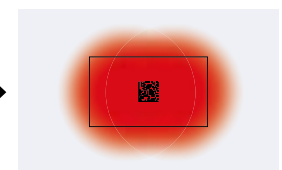

Light is concentrated efficiently within the field of view to provide high intensity illumination.

TWO MODES CAN BE SELECTED DEPENDING ON THE APPLICATION



UNAFFECTED BY CHANGING CONDITIONS

SMART MODE NEW

FOR CONSISTENT READING REGARDLESS OF CODE CONDITIONS



LIGHTER CODE

Fluctuations in code conditions are predicted during tuning and expanded reading settings are automatically generated. This ensures stable reading even when the contrast of the code changes, eliminating the need to reconfigure the code reader.

The reader predicts 43 patterns of change in printing conditions.

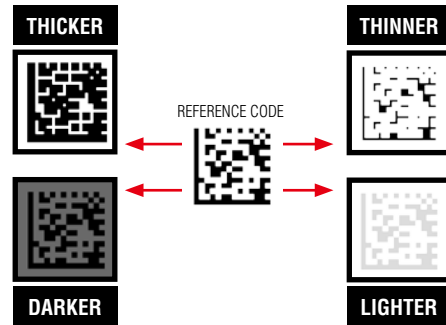

DETECTING CHANGES IN CODE CONDITIONS

CUSTOM MODE

FOR CODE QUALITY MANAGEMENT

The SR-1000 has the functionality to make judgments on code quality. Because code quality degradation can be detected before reading errors occur, this mode can be used for predictive maintenance of the printing process.

Matching level judgment function

Provides code quality comparison

Two codes, which both have a reading rate of 100%, can still be distinguished by the matching level



Reading rate **100%**
Matching level **75**



Reading rate **100%**
Matching level **43**

Code verification function

Verification based on code quality standards

OUTPUT DATA **AD-ERMT-55841:B**

TOTAL GRADE JUDGMENT

Judgment can also be given for each parameter

*This function is designed for 2D codes (QR, DataMatrix, GS1 Composite, PDF417).



SUPPORTED STANDARDS

- ISO/IEC 15415
- ISO/IEC TR 29158 (AIM DPM-1-2006)
- SAE AS9132
- SEMI T10-0701

EASY-TO-USE HIGH PERFORMANCE

ADVANCED SETUP SOFTWARE

AUTOID NETWORK NAVIGATOR **SR-H4W** NEW



The software provides not only easy code reader setup but also functionality to reduce man-hours for preliminary tests. It is now possible to connect to the software through USB. (SR-1000 Series only)

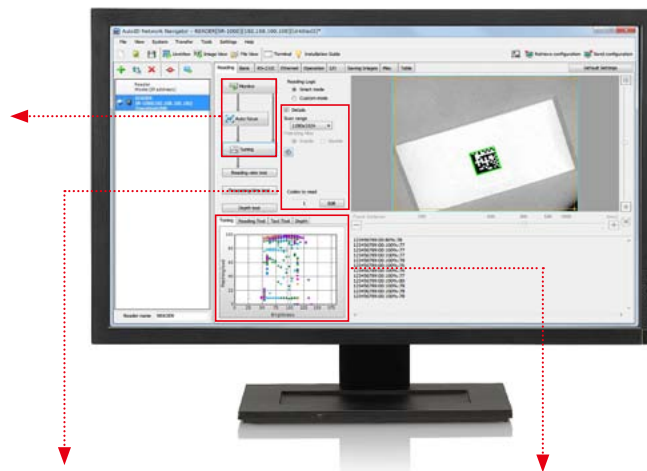
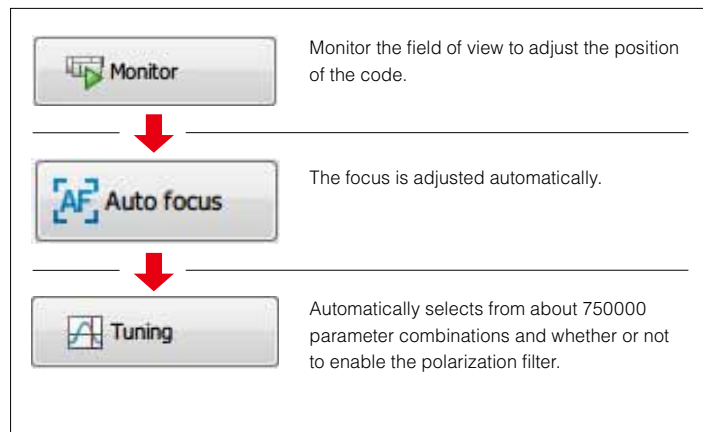

ADVANCED SETTINGS

Details

Image capture range
1280x1024

Polarizing filter
 Enable Disable

Bank to Tune/Test
1

Test with target bank

Codes to read
1

IMAGE CAPTURE RANGE

The smaller the range, the shorter the reading time becomes. Selectable from 800 × 600 mm 31.50" × 23.62", 1280 × 1024 mm 50.39" × 40.31", and user defined.

TARGET BANK (in custom mode only)

Specify the parameter bank number to modify.

POLARIZATION FILTER

Selectable between enabled or disabled.

TUNING HISTORY (in custom mode only)

Tuning history can be reviewed.

NO. OF CODES FOR READING

Specify the number of codes to read simultaneously.

TUNING MONITOR

The optimum settings are automatically determined from multiple combinations of image processing filters and brightness levels.

ETHERNET COMMUNICATION WIZARD NEW

Setup can be completed in just four steps with a question-answer form including visual explanations. In previous versions, the user needed to understand the settings available on the screen and determine which items required input. The new version uses a setup wizard to eliminate the need for item extraction, reducing man-hours for communication setup.



STEP 1 TRIGGER SETTINGS
(I/O input, command input)

STEP 2 DESTINATION FOR READ DATA
(Field network, PC)

STEP 3 COMMUNICATION PROTOCOL
(EtherNet/IP™, PROFINET, TCP, UDP, or PLC link)

STEP 4 ADVANCED SETTINGS
(Detailed setting for each protocol)

SOPHISTICATED MEASUREMENT MODES

The SR-1000 Series provides pre-verification prior to line operation based on tuning results as well as measurement of allowable line speed for reading codes at high speeds.

READING RATE MEASUREMENT

The reading success rate can be measured without conducting reading tests on multiple targets with the actual production line or equipment.

Tuning	Reading Test	Tact Test	Depth
Reading Test	100%		
Matching level	97		
Symbology	DataMatrix(12 x 12)		
Cell size	1.00mm		
Code size (width)	12.0mm		
PPC	25.0pixel/cell		
Read Data	123456789		

READING TACT MEASUREMENT

The reading cycle time (tact) can be determined without conducting reading tests on multiple targets with the actual production line or equipment.

Tuning	Reading Test	Tact Test	Depth
Read time	32ms		
Max time	33ms		
Min time	32ms		
Read Data	123456789		

READING DEPTH MEASUREMENT NEW

The depth of field can be determined from the mounting distance and the code used for tuning, without conducting reading tests on targets with the actual production line or equipment.

(When the mounting distance changes, perform re-tuning to enable reading again.)

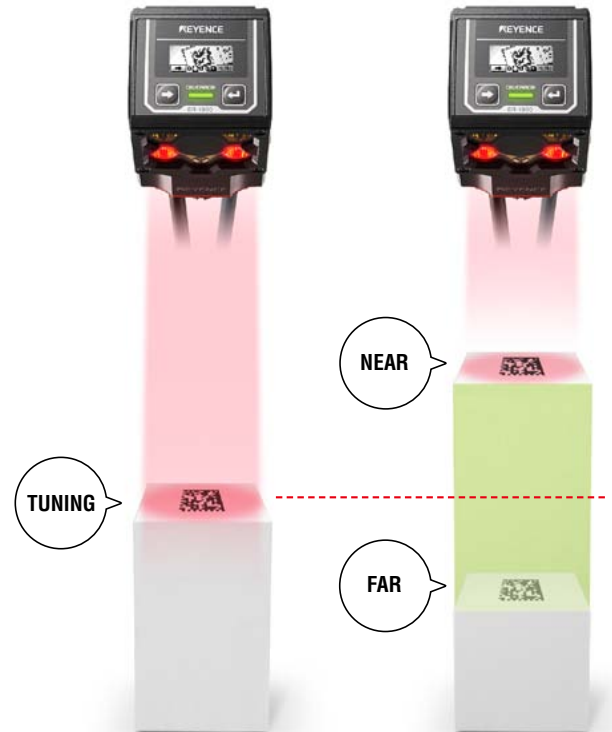
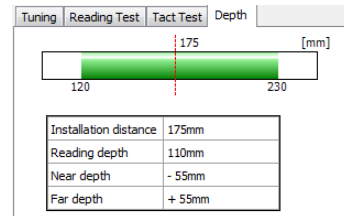

LINE SPEED MEASUREMENT NEW

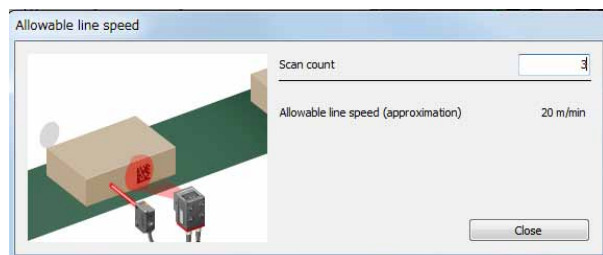

You can check allowable line speed before installation. This helps reduce man-hours spent adjusting production line designs or jigs.

FIRST-IN-ITS-CLASS, BUILT-IN ORGANIC LED (OLED) DISPLAY

CHECK OPERATION ON-SITE WITHOUT A PC

There is no need for a personal computer or monitor in the facility. The code position adjustment and operating condition can be checked simply with the intuitive built-in display.

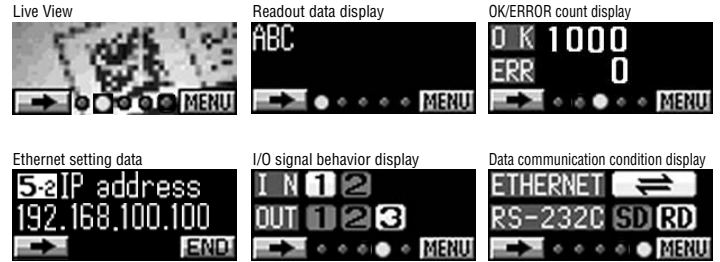

EASY SETUP WITHOUT A PC

You can set the optimal reading parameters after adjusting the code position by simply pressing the ENTER button to complete fully automatic tuning.

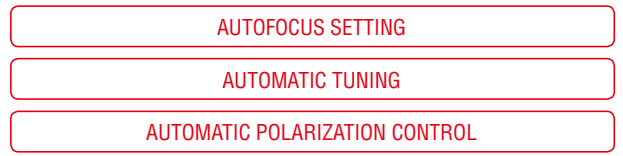

Reading test starts automatically.

HIGHLY-ADVANCED FUNCTIONS OFFER SIMPLE OPERATION

MASTER/SLAVE FUNCTION FOR USING MULTIPLE READERS EFFICIENTLY

This function reduces the programming load on the host computer drastically when multiple readers are used. Two modes are available: multi-drop link mode and multi-head mode.

* SR-D100/750 Series units can also be included in the connection.

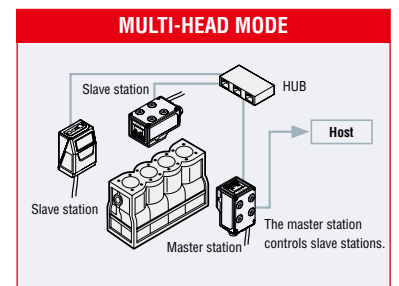
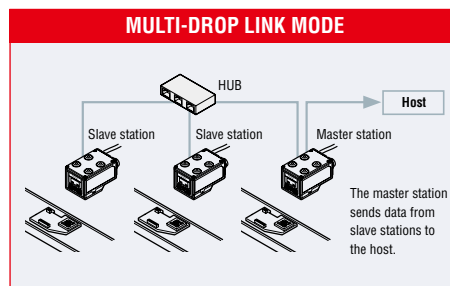

AUTOMATIC SELECTION OF OPTIMAL READING CONDITIONS (PARAMETER BANK FUNCTION)

CUSTOM MODE ONLY

The reader will automatically alternate between registered parameter banks until the proper reading conditions are determined.

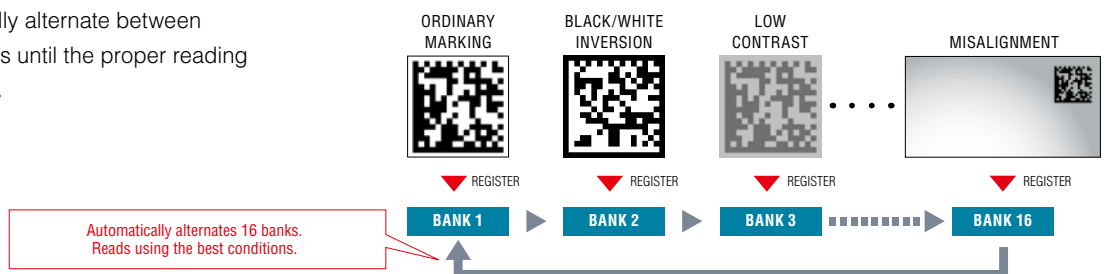

SYSTEM CONFIGURATION DIAGRAM

SR-1000 Series

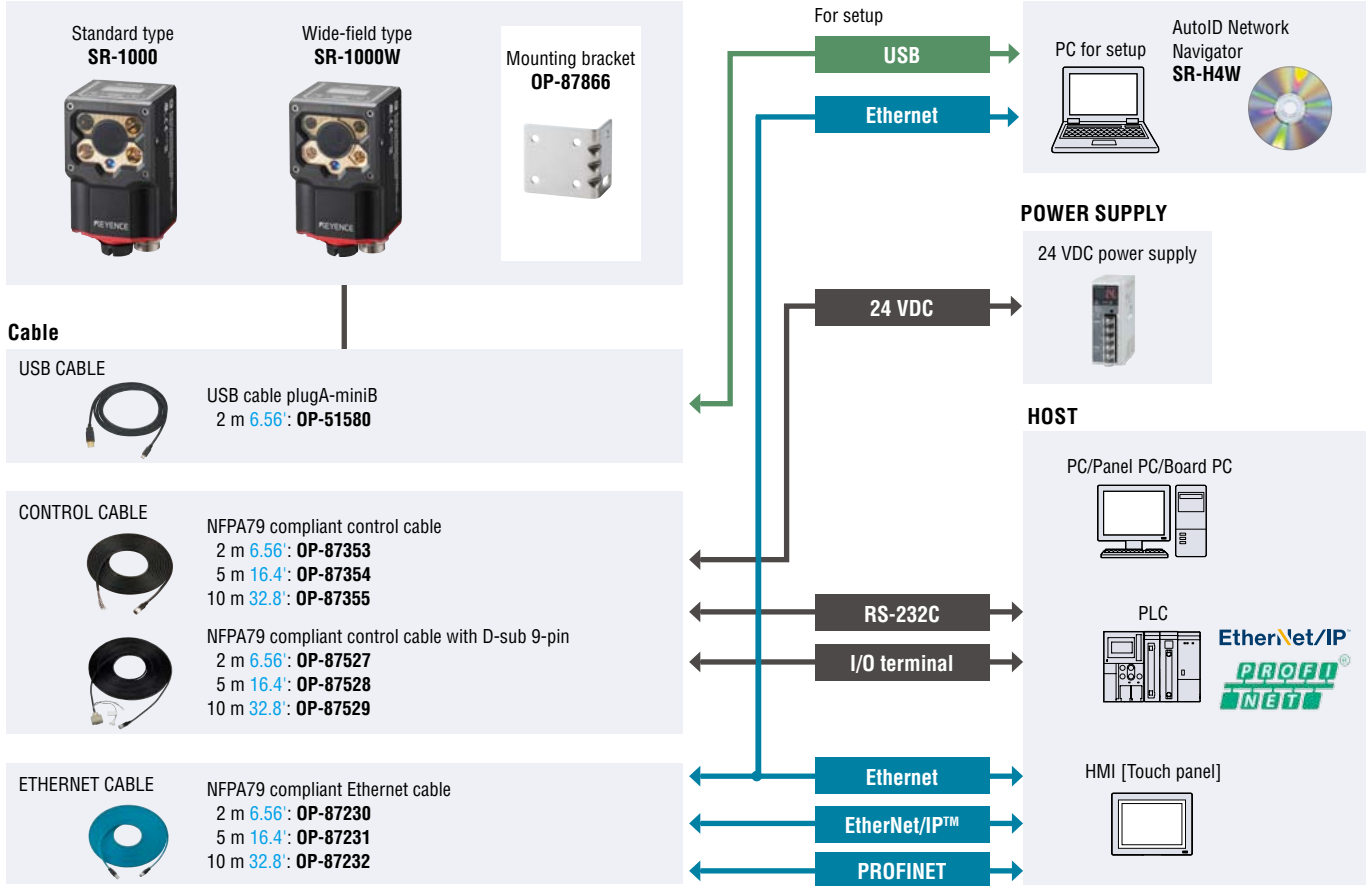

READING RANGE CHARACTERISTICS [TYPICAL]

SR-1000

MINIMUM RESOLUTION

Distance	Unit (mm inch)	
	2D	Barcode
110 4.33"	0.063 0.002"	0.082 0.003"
110 to 140 4.33" to 5.51"	0.082 0.003"	
110 to 230 4.33" to 9.06"	0.14 0.006"	
110 to 300 4.33" to 11.81"	0.18 0.007"	0.11 0.004"
110 to 400 4.33" to 15.75"	0.24 0.009"	0.15 0.006"
110 to 600 4.33" to 23.62"	0.37 0.015"	0.22 0.009"
110 to 1000 4.33" to 39.37"	0.61 0.024"	0.37 0.015"

FIELD OF VIEW

Distance	Image capture range (1280 × 1024 50.39° × 40.31°)		Image capture range (800 × 600 31.50° × 23.62°)	
	Width	Height	Width	Height
110 4.33"	30 1.18"	24 0.94"	19 0.75"	14 0.55"
140 5.51"	40 1.57"	32 1.26"	25 0.98"	18 0.71"
230 9.06"	68 2.68"	54 2.13"	42 1.65"	32 1.26"
300 11.81"	90 3.54"	72 2.83"	56 2.20"	42 1.65"
400 15.75"	122 4.80"	97 3.82"	76 2.99"	57 2.24"
600 23.62"	185 7.28"	148 5.83"	116 4.57"	87 3.43"
1000 39.37"	312 12.28"	250 9.84"	195 7.68"	146 5.75"

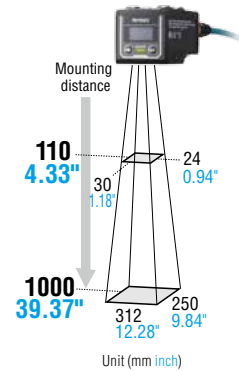

SR-1000W

MINIMUM RESOLUTION

Distance	Unit (mm inch)	
	2D	Barcode
50 1.97"	0.082 0.003"	0.082 0.003"
50 to 100 1.97" to 3.94"	0.14 0.006"	
50 to 150 1.97" to 5.91"	0.20 0.008"	0.12 0.005"
50 to 230 1.97" to 9.06"	0.30 0.012"	0.18 0.007"
50 to 300 1.97" to 11.81"	0.38 0.015"	0.23 0.009"
50 to 400 1.97" to 15.75"	0.51 0.020"	0.31 0.012"
50 to 600 1.97" to 23.62"	0.76 0.030"	0.45 0.018"

FIELD OF VIEW

Distance	Image capture range (1280 × 1024 50.39° × 40.31°)		Image capture range (800 × 600 31.50° × 23.62°)	
	Width	Height	Width	Height
50 1.97"	35 1.38"	28 1.10"	22 0.87"	16 0.63"
100 3.94"	67 2.64"	54 2.13"	42 1.65"	31 1.22"
150 5.91"	99 3.90"	79 3.11"	62 2.44"	46 1.81"
230 9.06"	150 5.91"	120 4.72"	93 3.66"	70 2.76"
300 11.81"	194 7.64"	155 6.10"	121 4.76"	91 3.58"
400 15.75"	257 10.12"	206 8.11"	161 6.34"	120 4.72"
600 23.62"	384 15.12"	307 12.09"	240 9.45"	180 7.09"

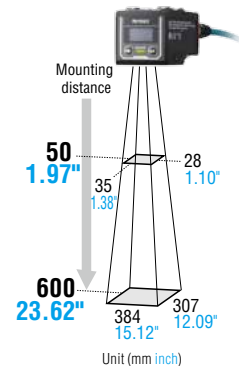

SPECIFICATIONS



Main unit

Model		SR-1000	SR-1000W	
Type		Standard type	Wide-field type	
Receiver	Sensor	CMOS Image Sensor		
	Number of pixels	1280 × 1024 pixels	1280 × 1024 pixels	
Light emitter	Illumination light source	High intensity red LED		
	Pointer light source	High intensity green LED		
Focus adjustment		Autofocus*		
Reading specifications	Supported symbol	2D	QR, MicroQR, DataMatrix (ECC200), GS1 DataMatrix, PDF417, Micro PDF417, GS1 Composite (CC-A, CC-B, CC-C)	
		Barcode	GS1 DataBar, CODE39, CODE39 Full ASCII, ITF, NW-7 (Codabar), CODE128, 2of5 (Industrial 2of5), COOP 2of5, GS1-128, JAN/EAN/UPC, Trioptic CODE39, CODE93, Pharmacode	
	Minimum resolution	2D	0.063 mm 0.002"	0.082 mm 0.003"
		Barcode	0.082 mm 0.003"	0.082 mm 0.003"
Reading distance		110 mm to 1000 mm 4.33" to 39.37"	50 mm to 600 mm 1.97" to 23.62"	
Field of view for reading (Typical example at 400 mm)		122 × 97 mm 4.80" × 3.82"	257 × 206 mm 10.12" × 8.11"	
I/O specifications	Control input	Number of inputs	2	
		Input type	Bidirectional voltage input	
		Maximum rating	26.4 VDC	
		Minimum ON voltage	15 VDC	
		Maximum OFF current	0.2 mA or less	
	Control output	Number of outputs	3	
		Output type	Photo MOS relay output	
		Maximum rating	30 VDC	
		Maximum load current	1 output: 50 mA or less, Total of 3 outputs: 100 mA or less	
		Leakage current when OFF	0.1 mA or less	
		Residual voltage when ON	1 V or less	
	Ethernet	Communication standard	IEEE 802.3 compliant, 10BASE-T/100BASE-TX	
		Supported protocol	TCP/IP, SNMP, FTP, BOOTP, MC Protocol, Omron PLC link, KV STUDIO, EtherNet/IP™, PROFINET	
	Serial communication	Communication standard	RS-232C compliant	
Transmission speed		9600, 19200, 38400, 57600, 115200 bps		
USB	Supported protocol	No-protocol, MC Protocol, SYSWAY, KV STUDIO		
	Communication standard	USB 2.0 Full Speed compliant		
Environmental resistance	Enclosure rating	IP65		
	Ambient temperature	0 to +45°C 32 to 113°F		
	Ambient storage temperature	-10 to +50°C 14 to 122°F		
	Relative humidity	35 to 85% RH (No condensation)		
	Storage ambient humidity	35 to 85% RH (No condensation)		
	Ambient luminance	Sunlight: 10000 lux, Incandescent lamp: 6000 lux, Fluorescent lamp: 2000 lux		
Rating	Operating environment	No dust or corrosive gas present		
	Vibration	10 to 55 Hz Double amplitude 0.75 mm 0.030"; 3 hours each in X, Y and Z directions		
Weight	Power voltage	24 VDC ±10%		
	Current consumption	Approx. 700 mA		
Weight		Approx. 200 g		

* The focal position can be adjusted automatically during installation.

Setup software

Model	SR-H4W
Supported OS	Microsoft Windows 8 Professional or later 32bit/64bit (Except for Windows RT) Microsoft Windows 7 Professional or later 32bit/64bit Microsoft Windows VISTA Business/Ultimate SP2 or later 32bit
Running environment*	•RAM: System memory 1 GB or more (2 GB or more for 64 bit OS) •Screen resolution: 1024 × 768 or more

* .NET Framework 3.5 SP1 or above has been installed.

DIMENSIONS

Unit: mm inch

Main unit SR-1000/1000W

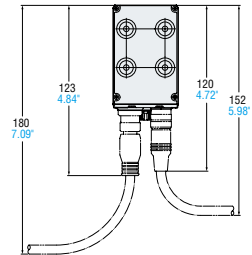
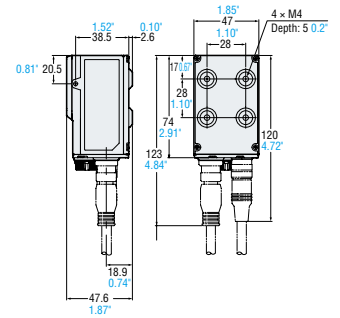

When the mounting bracket (OP-87866) is used

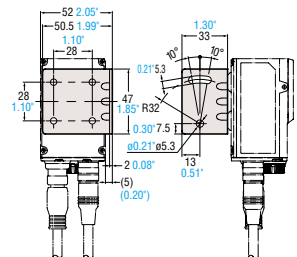

CALL TOLL FREE

TO CONTACT YOUR LOCAL OFFICE
1-888-KEYENCE
1 - 8 8 8 - 5 3 9 - 3 6 2 3

www.keyence.com



SAFETY INFORMATION

Please read the instruction manual carefully in order to safely operate any KEYENCE product.

KEYENCE CORPORATION OF AMERICA

Corporate Office 669 River Drive, Suite 302, Elmwood Park, NJ 07407 PHONE: 888-539-3623 FAX: 855-539-0123 E-mail: keyence@keyence.com

Sales & Marketing Head Office 1100 North Arlington Heights Road, Suite 210, Itasca, IL 60143 PHONE: 888-539-3623 FAX: 855-539-0123

AL Birmingham	CO Denver	IN Indianapolis	MI Detroit	NJ Elmwood Park	OH Cincinnati	PA Pittsburgh	TX Austin	WI Milwaukee
AR Little Rock	FL Tampa	KS Kansas City	MI Grand Rapids	NY Rochester	OH Cleveland	SC Greenville	TX Dallas	
CA N. California	GA Atlanta	KY Louisville	MN Minneapolis	NC Charlotte	OR Portland	TN Knoxville	VA Richmond	
CA Los Angeles	IL Chicago	MA Boston	MO St. Louis	NC Raleigh	PA Philadelphia	TN Nashville	WA Seattle	

KEYENCE CANADA INC.

Head Office PHONE: 905-366-7655 FAX: 905-366-1122 E-mail: keyencecanada@keyence.com
Montreal PHONE: 514-694-4740 FAX: 514-694-3206 **Windsor** PHONE: 905-366-7655 FAX: 905-366-1122

KEYENCE MEXICO S.A. DE C.V.

PHONE: +52-81-8220-7900 FAX: +52-81-8220-9097
E-mail: keyencemexico@keyence.com

The information in this publication is based on KEYENCE's internal research/evaluation at the time of release and is subject to change without notice.
Copyright (c) 2014 KEYENCE CORPORATION. All rights reserved.

SR1000-KA-C-US 1114-2 [611929] Printed in Japan



KA1-1124